



Optics  
**Shinland**

Each Ray is brighter in Shinland

# SL-050A

## Details

---

|                 |                            |
|-----------------|----------------------------|
| Material:       | URC2500                    |
| Cover Material: | PC                         |
| Process:        | Vaccum Aluminum Plating PC |
| MAX Diameter:   | 50.0mm                     |
| Height:         | 35.1mm                     |
| Matched Holder: | SL-HD-A                    |
| Matched Cover:  | WITHOUT                    |
| ROSH Compliant: | YES                        |
| Status:         | Ready                      |

## Optical Properties

---

| Code      | Typ. FWHM | Typ. Eff |
|-----------|-----------|----------|
| SL-05015A | 15°       | 90%      |
| SL-05024A | 24°       | 90%      |
| SL-05038A | 38°       | 90%      |
| SL-05060A | 60°       | 90%      |

---

## Photo



## Matched LED Source

CLU028

CXM-9

CHM-9

CXA15

V10 Gen6

V10 Gen7

E8

Soleroq S8

Soleroq S9

Soleroq S10

105

1202/1203

G4-10

LC020C

LC006B

EDC-38C

NFCxL036B

# Dimensional Figure SL-050A

Measure Unit: mm

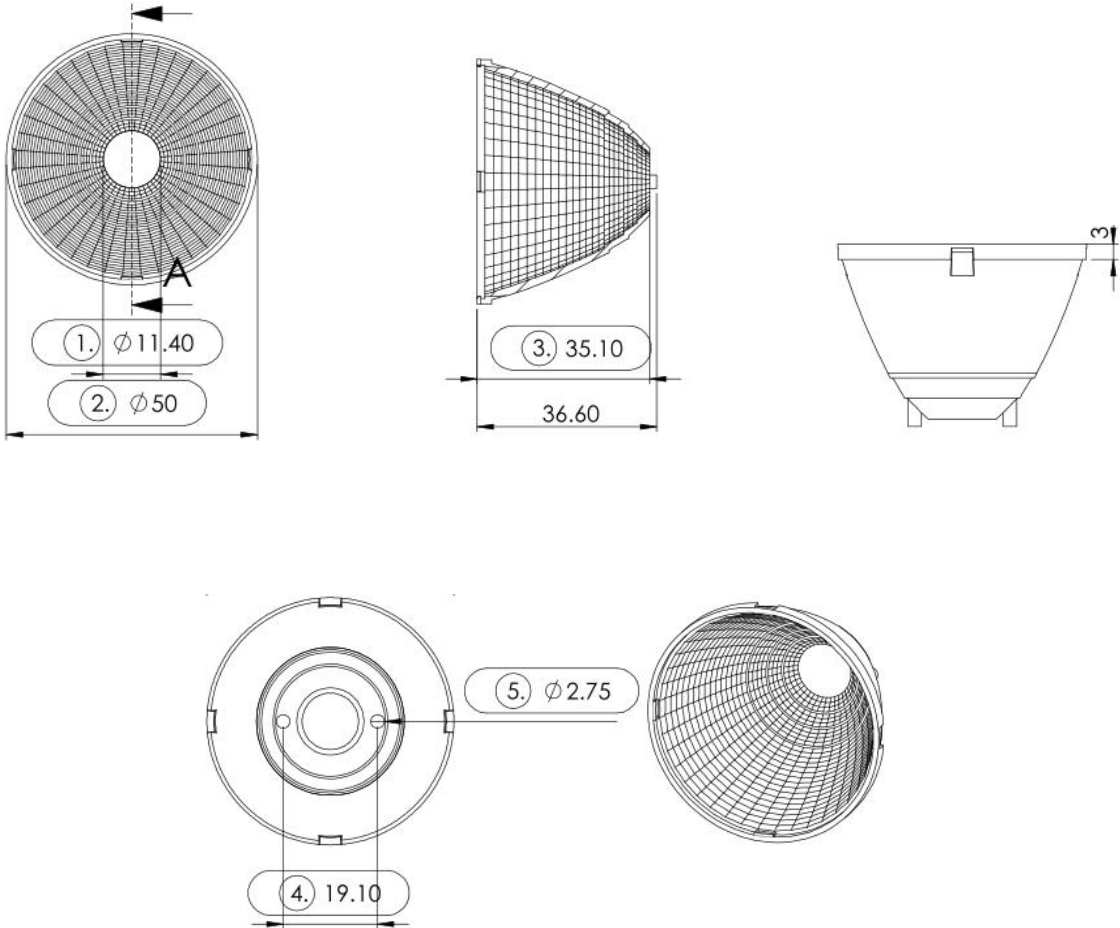

# Dimensional Figure

## SL-CXA15-HD-A

Measure Unit: mm

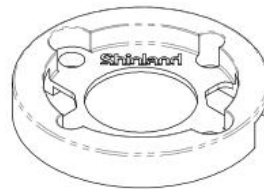
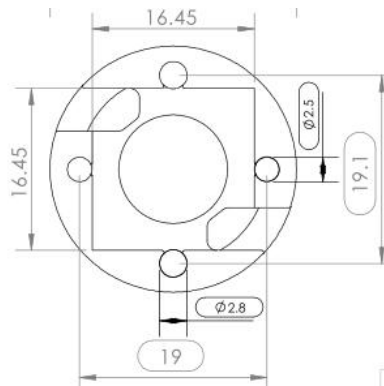
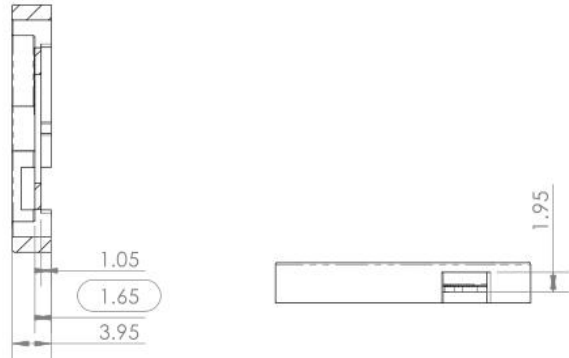
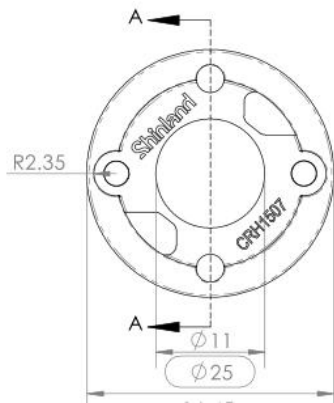

# Dimensional Figure

## SL-CXM-9-HD-A

Measure Unit: mm

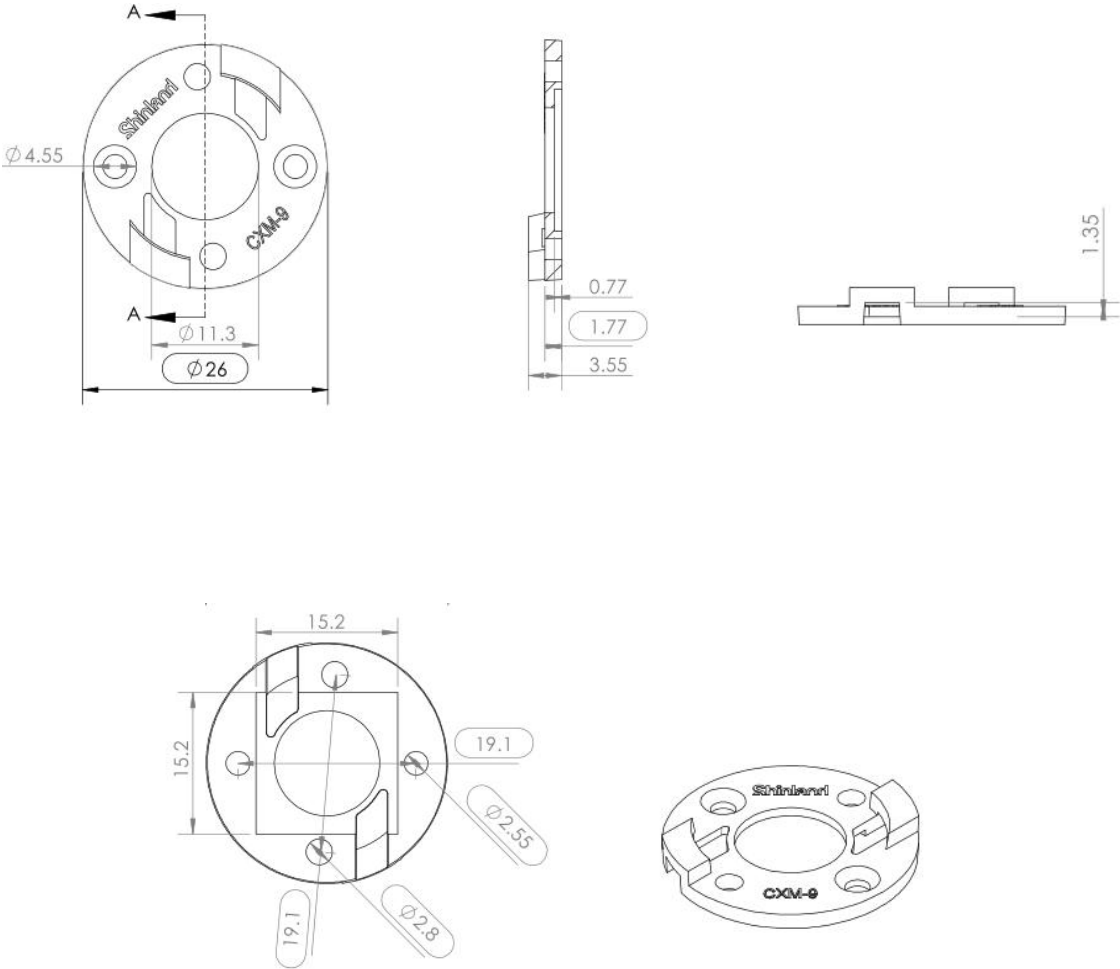

# Distribution Curve Flux

## SL-050A&SL-CXA15-HD-A

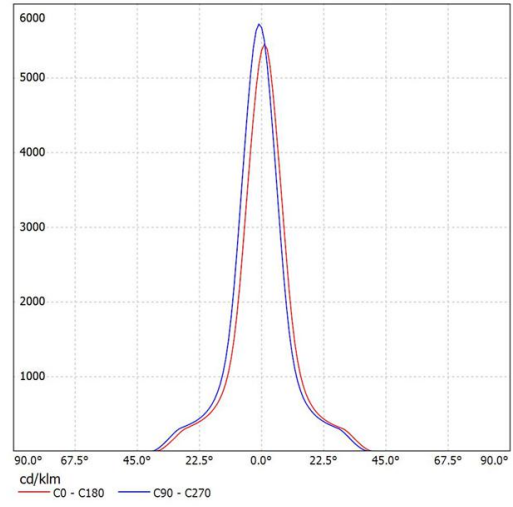
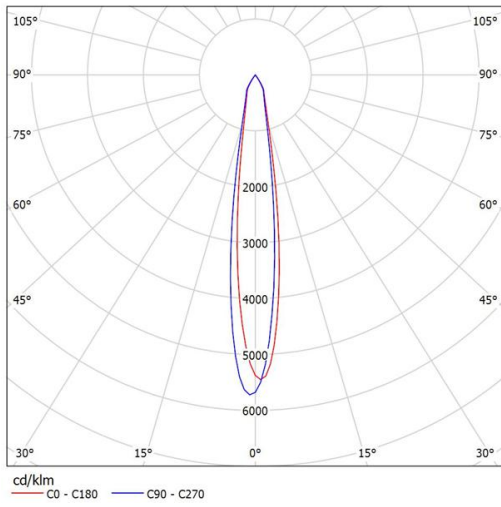

SL-05015A  
K:7.35cd/lm,LED:1507

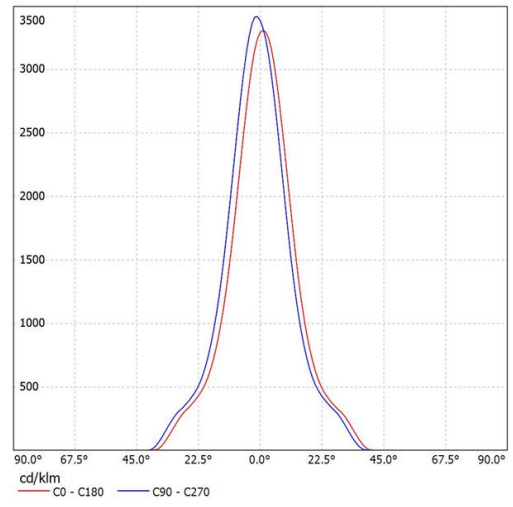
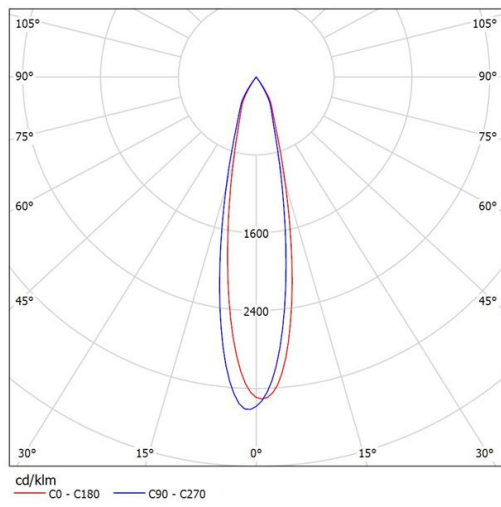

SL-05024A  
K:4.35cd/lm,LED:1507

# Distribution Curve Flux

## SL-050A&SL-CXA15-HD-A

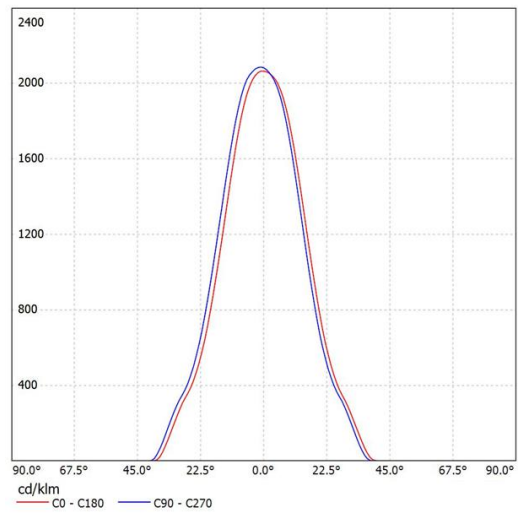
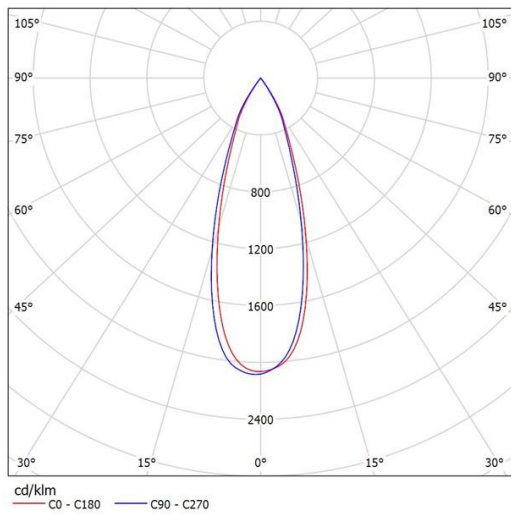

SL-05038A  
K:2.64cd/lm,LED:1507

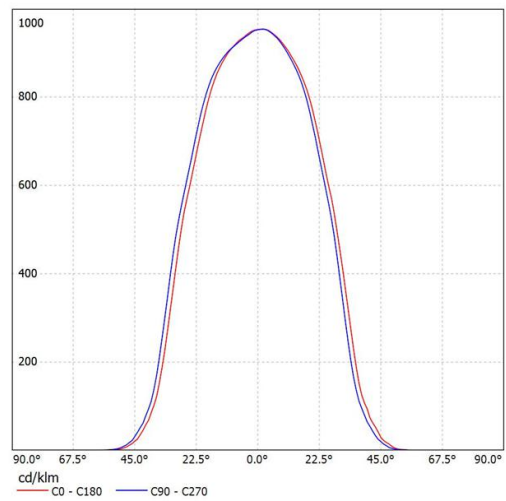
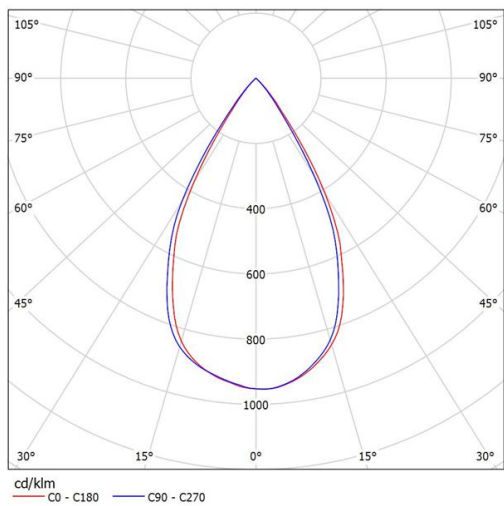

SL-05060A  
K:1.24cd/lm,LED:1507

# Distribution Curve Flux

## SL-050A&SL-CXM-9-HD-A

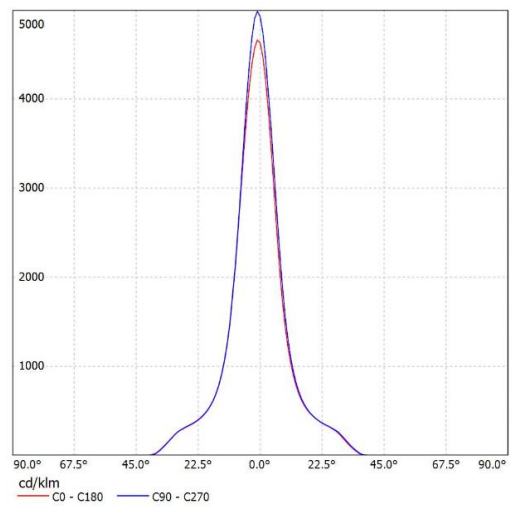
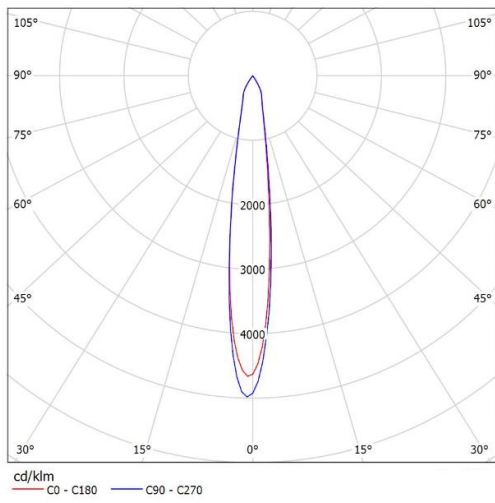

SL-05015A  
K:7.26cd/lm,LED:CXM-9

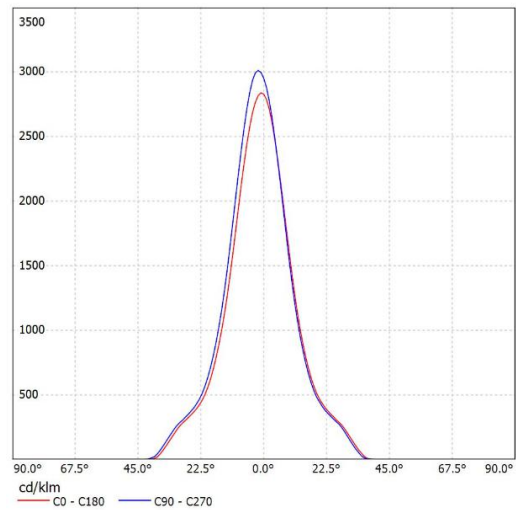
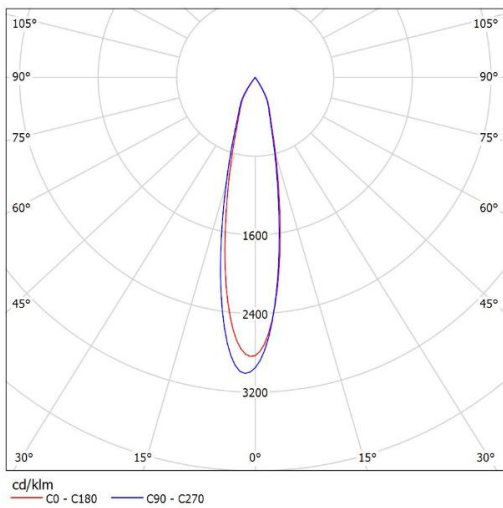

SL-05024A  
K:4.33cd/lm,LED:CXM-9



# Distribution Curve Flux

## SL-050A&SL-CXM-9-HD-A

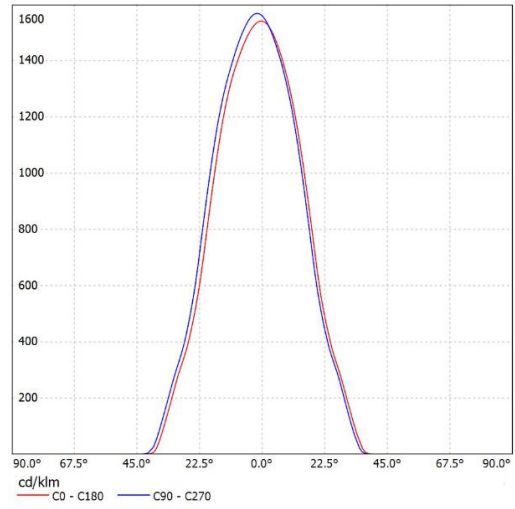
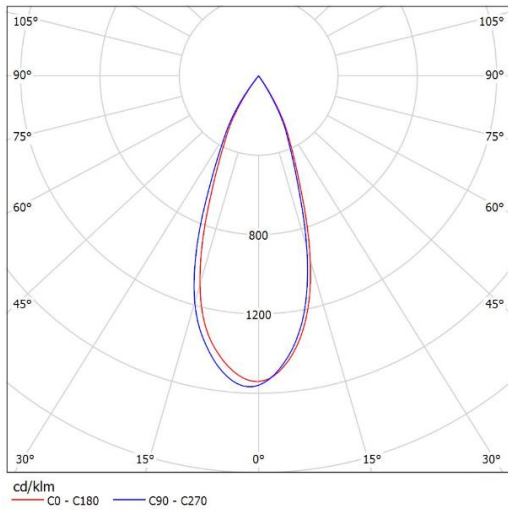

**SL-05038A**  
K:2.26cd/lm,LED:CXM-9

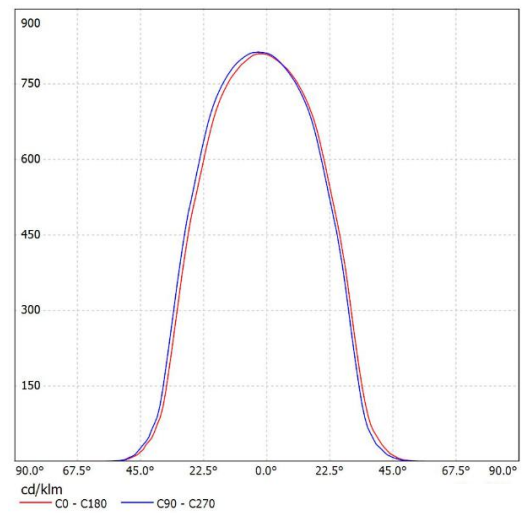
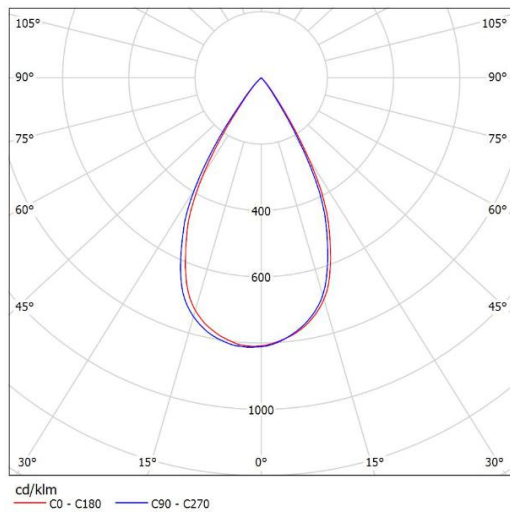

**SL-05060A**  
K:1.31cd/lm,LED:CXM-9

# Distribution Curve Flux

## SL-050A&SL-CLL020-HD-A

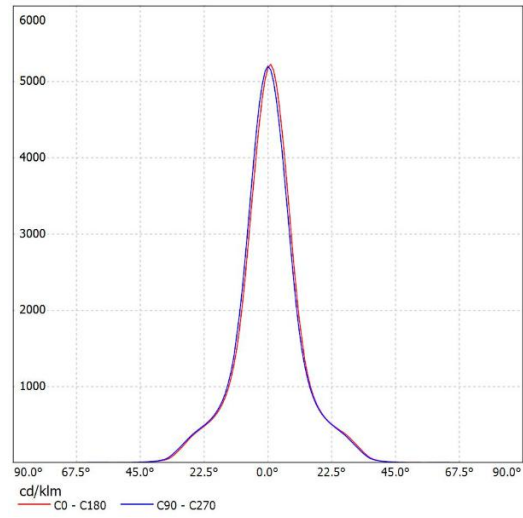
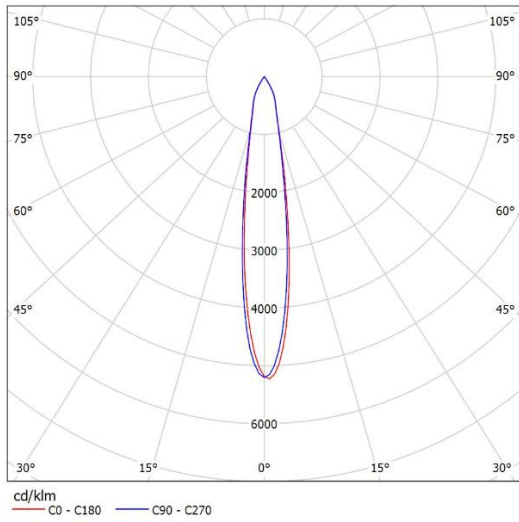

SL-05015A  
K:6.06cd/lm,LED:CLL02X

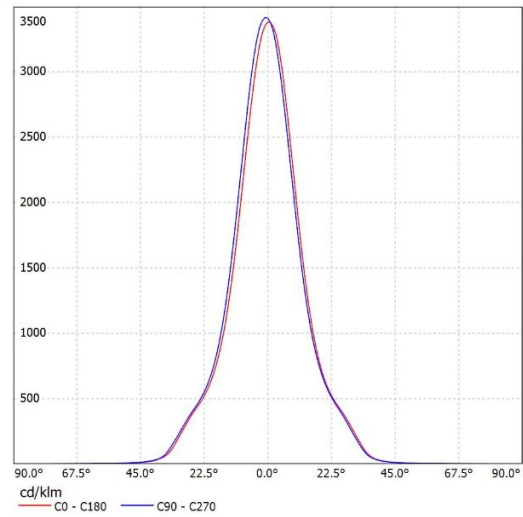
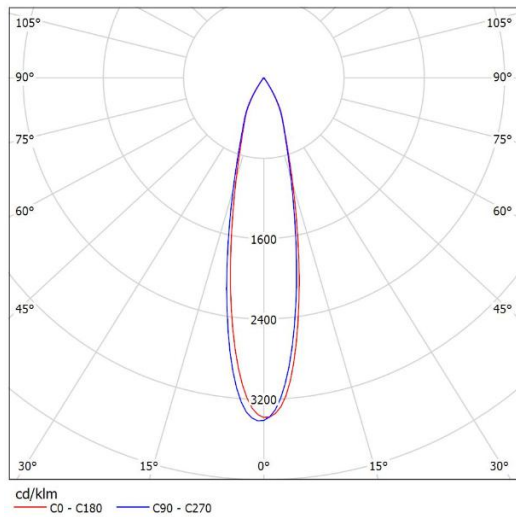

SL-05024A  
K:3.99cd/lm,LED:CLL02X

# Distribution Curve Flux

## SL-050A&SL-CLL020-HD-A

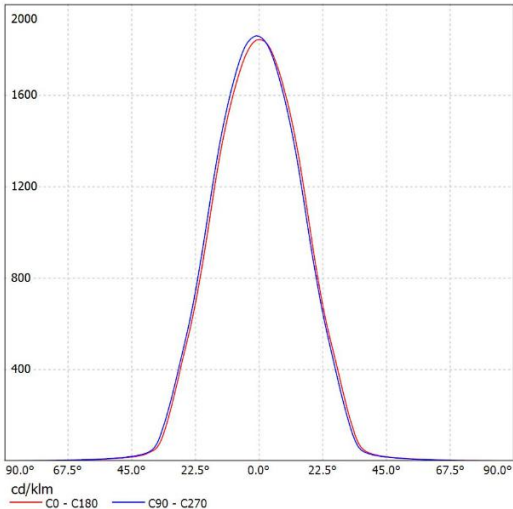
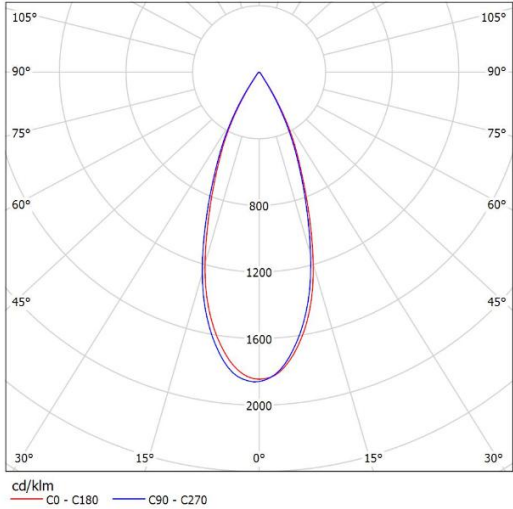

**SL-05038A**  
K:2.20cd/lm,LED:CLL02X

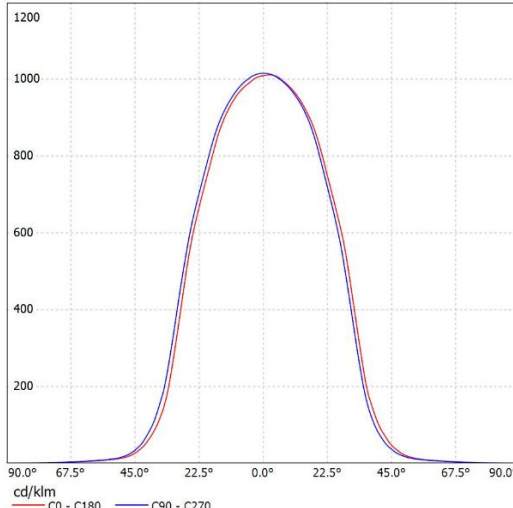
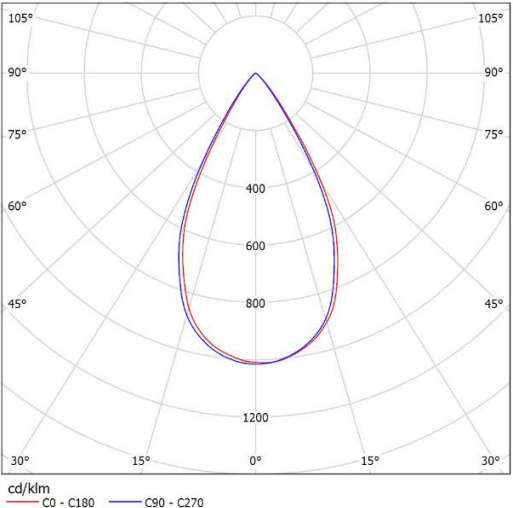

**SL-05060A**  
K:1.26cd/lm,LED:CLL02X

## Package Description

SL-050A

| PART NO.  | WITHOUT PC COVER        |                   | WITH PC COVER           |                   | BOX SIZE<br>(cm) |
|-----------|-------------------------|-------------------|-------------------------|-------------------|------------------|
|           | Number Per<br>Box (pcs) | Box Weigh<br>(kg) | Number Per<br>Box (pcs) | Box Weigh<br>(kg) |                  |
| SL-05015A | 600                     | 6.03              | *                       | *                 | 60X 32 X 40      |
| SL-05024A | 600                     | 5.85              | *                       | *                 | 60 X 32 X 40     |
| SL-05038A | 600                     | 6.70              | *                       | *                 | 60 X 32 X 40     |
| SL-05060A | 600                     | 9.25              | *                       | *                 | 60 X 32 X 40     |

## Notes

- It is not allowed to scrub the reflective surface. If there is dust on the surface, please clean by soft cotton with little water.
  - It is forbidden to clean with industrial solvent such as ethanol.
  - Storage temperature: 0°C-40°C, and humidity:30%-95%.
  - Recommended operating temperature (PC) is <100°C.
  - Keep reflectors in package to void the dust.
  - Prohibit the reflector touch with acid or alkaline solvent
- 

## About Shinland

Shenzhen Shinland Co. Ltd,one of the longest and most professional company in lighting optical field,have 20 years experience.Different from other factory which only have simple process, all aspects included R&D,making mold,injection molding ,vacuum coating and market support are our company own vertically integrated production .

Insisting on 'Quality First, Service First' and pragmatic, enterprising spirit,building the market by quality, casting our brand by credibility and integrity ,Shinland now become the leading supplier of lighting optical solution in China.